



Air Top Installation Guide - AT2000STC



Webasto Air Top Installation Guide – AT2000STC

General Information

Webasto Thermo & Comfort Australia Pty Ltd is pleased to provide this installation guide for the Air Top 2000STC heating system. When used according to the guidelines stated in this booklet, you should expect many years of trouble-free, enjoyable operation.

This installation guide represents our latest effort to produce the best technical documentation possible. In our efforts toward continuous, ongoing product improvement, we also encourage our customers to provide feedback concerning this guide and the Air Top 2000STC heating system.

Visit our website for technical documents: www.webasto.com/au

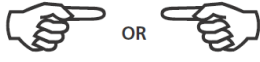
	Indicates an imminently hazardous situation which, if not avoided, WILL result in death or serious injury.
	Indicates a potentially hazardous situation which, if not avoided, COULD result in death or serious injury.
	Indicates a potentially hazardous situation which, if not avoided, MAY result in minor or moderate injury or property damage. It may also be used to alert against unsafe practices.
	These symbols are used to alert the installer to important or useful information about proper installation of the equipment.



This Webasto Diesel Heater comes with a 2 year warranty.

Failure to follow these installation instructions and the notes contained therein will lead to all warranty being refused by Webasto Thermo & Comfort Australia Ltd Pty . The same applies if the repairs are carried out incorrectly or with use of parts other than genuine Webasto service parts. This will result in the voiding of all warranty. All service and repairs have to be carried out by authorised Webasto service dealers.

Purpose of the Air Top Heater

The Webasto Air Top 2000STC air heaters are designed to heat the cabins of boats, trucks, minibus', vans, motorhomes, caravans and camper trailers.

The air heaters operate independently of the engine and are connected to either the vehicle's own fuel tank or via a separate fuel tank and the electrical system of the vehicle.

They are not designed to heat hazardous substances.

Webasto Air Top Installation Guide – AT2000STC

Pre-Installation Considerations

- 1) Location and orientation of the heater.
The heater may be fitted to the interior or exterior of the vehicle. If it is installed externally, ensure that the heater is fitted in a position where it is protected from water and dust ingress.
- 2) Length of hot air outlet ducting – the shorter, the better. Ensure that the hot air outlet is not directed towards or in contact with the human body, as the hot air temperature can range from 80-120°C.
- 3) Return vent - in some cases where there is enough air circulation in and around the heater, ducting may not be required to the return air vent. Where it is required, keep ducting to a minimum.
- 4) Location of the controller, electrical wiring, fuse and battery connections.
- 5) Location of the fuel pump and fuel filter.
- 6) Location of the exhaust system. Ensure that the exhaust is not facing direction of travel.
- 7) Location of the combustion air systems.
- 8) Fuel pick-up options – 12L Webasto fuel tank or standpipe.
- 9) Electrical - ensure to use the supplied fuses in the kit and battery positive and negative connected directly to the house battery.

Tips

Loosely attach the heater with the mounting bracket and place it in your desired location to predetermine the heater orientation, ducting layout, airflow, wiring, controller and general clearance for easy accessibility and for future service and repair.

Serial Number Labelling

Ensure that the serial number labels are attached on the top or the side of the heater in case the heater is mounted against a wall and the original label may be inaccessible. Additional labels are supplied in the kit and one should go on the installation manual envelope to hand over to the customer at the time of commissioning.



Fig 1 – Serial number labels – Heater

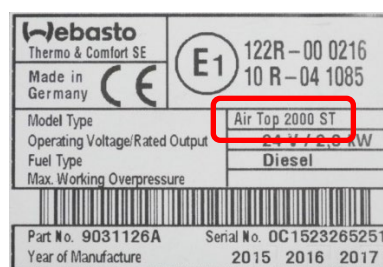

Fig 2 – Serial number label written as Fabr Nr.

The Serial Number label on the AT2000STC will still state AT2000ST. This is to avoid the necessity of applying for a new EC type approval. The heater will still be an AT2000STC based on the manufacture date and serial number.

Note: In case of warranty situations, the serial number will be requested by Webasto or an authorised dealer to validate.

Webasto Air Top Installation Guide – AT2000STC

Heater & Floor Mounting Bracket Dimensions

Note: All dimensions in millimetres

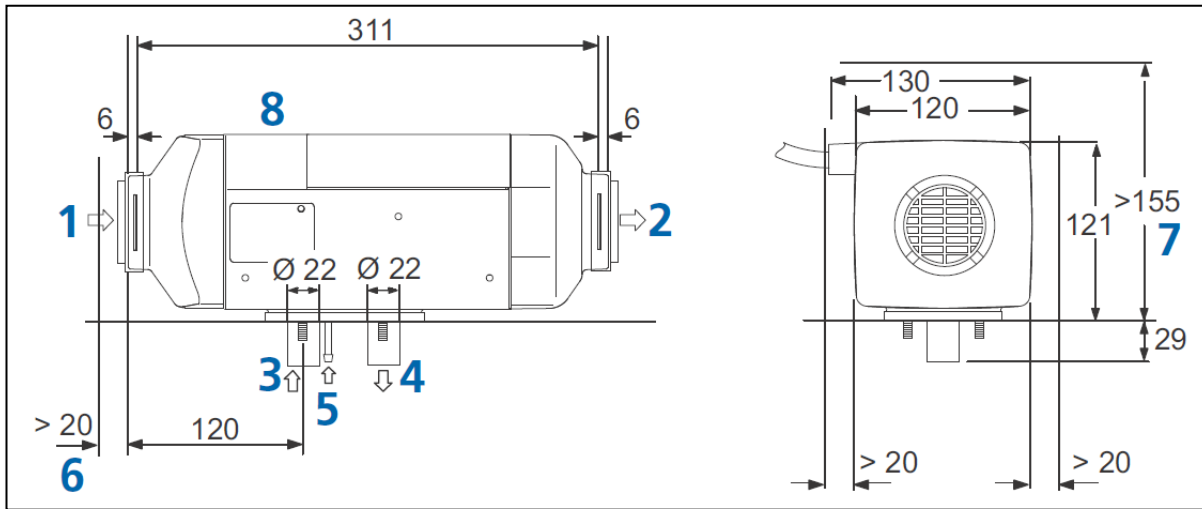

1 Heating Air Inlet	5 Fuel Inlet
2 Heating Air Outlet	6 Space Requirement for Heating Air Inlet
3 Combustion Air Inlet	7 Space Requirement for Installation & Removal of Heater
4 Exhaust Gas Outlet	8 Cable Outlet (Optional Right or Left)

Fig 3

Floor Mounting Bracket

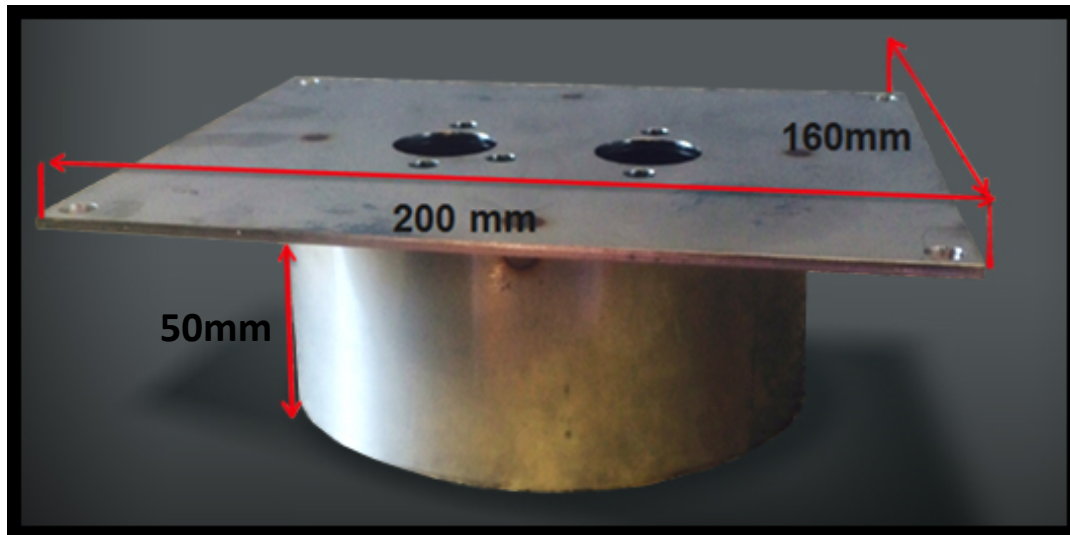

Fig 4

Webasto Air Top Installation Guide – AT2000STC

Step by Step Installation

1. After checking what is under the floor to ensure clearance of tanks, chassis rails etc., Drill the 140mm floor mount bracket cut out.
2. **Assembly of the heater**
 - 2.1 Assemble the heater to the bracket with the rubber gasket using the 10mm nuts and washers supplied in the kit.

(Rubber gasket must be applied to avoid any heat distribution through the vehicle floor)

⚠ WARNING *The seal gasket must be replaced each time the heater is removed and reinstalled.*



Fig 5

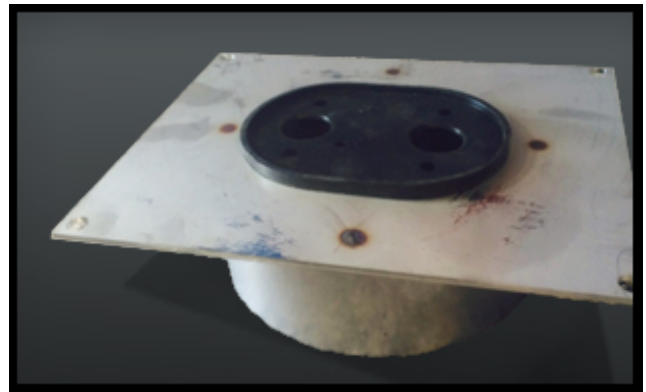

Fig 6

- 2.2 Place the heater so the bracket is facing up (Fig 7), you will now notice electrical wires bundled in the combustion air inlet (Fig 3) (3), these 2 black wires are for the fuel pump.

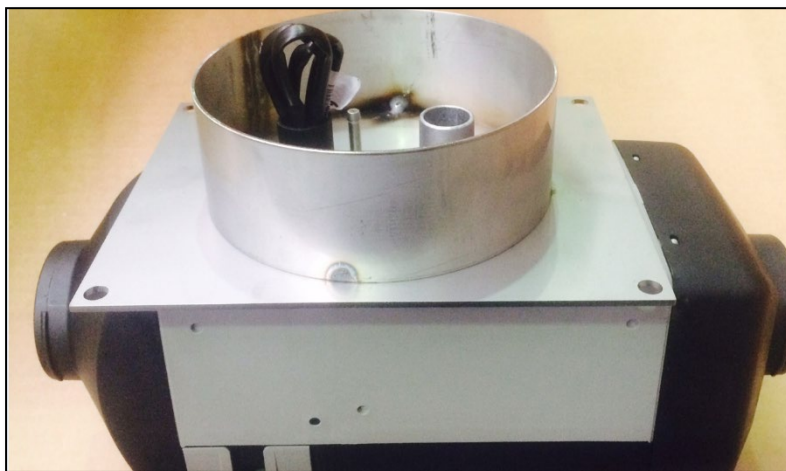

Fig 7 – Bracket facing upwards and notice the wires in the combustion air inlet.

Webasto Air Top Installation Guide – AT2000STC

2.4 The combustion air inlet (Fig 3) (3) has a slot to accommodate the wires, ensure the fuel pump wires sit neatly in this slot. Never run the wires through the combustion air inlet tube as it will create air restrictions.



Fig 8

2.5 Attaching combustion air tube. A matching slot needs to be cut in one end of the combustion air tube to accommodate the fuel pump wires.



Fig 9 – Combustion Air Tube “V” cut.



Fig 9a – Combustion Air Filter

2.6 Using the 25mm hose clamp, fix the combustion air tube to the inlet (Fig 3) (3).

Note: Ensure that the hose clamp & fuel pump wires are not rubbing.



*Under no circumstance may the combustion air be taken from areas occupied by people. The combustion air intake opening must **not** point in the direction of travel. It must be located so that it cannot become clogged with dirt or road debris.*

The combustion air must be extracted using a combustion air tube supplied in the kit and protected from dust and water ingress.

Webasto Air Top Installation Guide – AT2000STC

2.7 Attach the fuel line using the 10mm hose clamp & rubber fuel line connector, fix to the fuel inlet (Fig 3) (5), then fix the fuel line to the open end of the rubber connector and secure with another 10mm hose clamp. (Ref: Fig 8).

2.8 Install the stainless steel exhaust pipe, using the 25 mm exhaust clamp to the exhaust gas outlet (Fig 3) (5).



The exhaust pipe temperature is above 250°C. Ensure that the end cap is properly mounted and pointing downwards (fig 11.1). The exhaust **must not** point in the direction of travel. **The exhaust must be secured and away from heat sensitive components, vehicle fuel lines and harnesses.** Webasto can supply exhaust lagging if required.

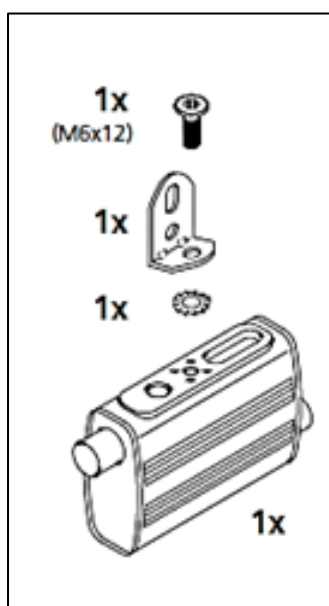

Fig 10 an exhaust muffler is supplied in the kit.

Fig 11 – The exhaust or combustion pipe must be located so that they cannot be clogged by dirt or road debris

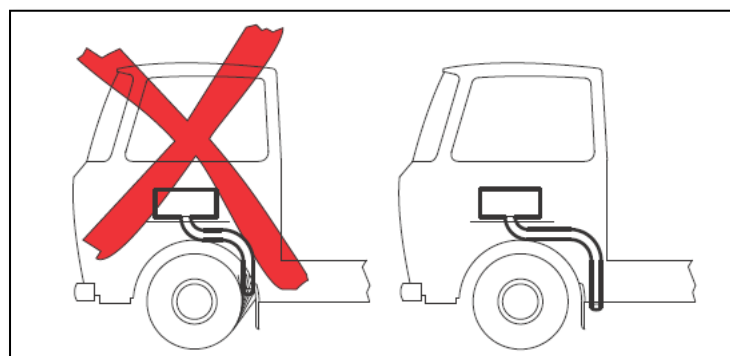

Fig 11.1 – Ensure that the end cap is properly mounted and pointing downwards on the exhaust pipe.

Webasto Air Top Installation Guide – AT2000STC

3 Electrical System

3.1 Main Harness

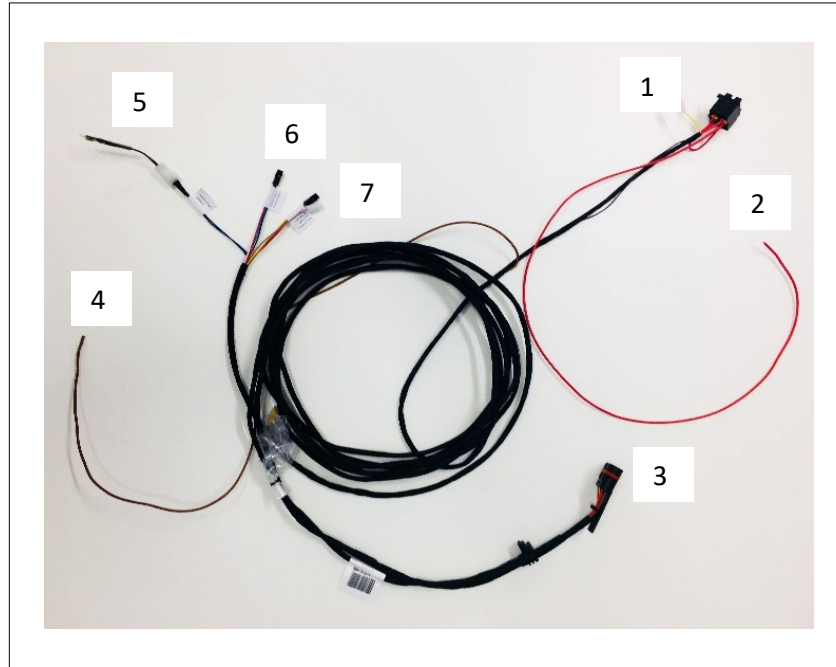

Fig 12 – AT2000STC Main Harness connections

Number	Function
1	Diagnostic Plug
2	Red Wire (Battery Positive)
3	Main Plug
4	Brown Wire (Battery Negative)
5	620 Ohm Resistor
6	Rotary Controller (Potentiometer)
7	Multi-control digital

Do not cut or extend the controller wiring harness. This will void the warranty. If an extension is required for the control element plug (Fig 12) (X9), an extension harness is available from Webasto.

We only recommend extending the battery positive (red) and negative (brown) wires. Correct wire size of 6mm to be used to avoid any current or voltage drop in the circuit.

Ensure that the main plug is properly “home” in the ECU (Fig 12) (3). The main positive (red) and negative (brown) has to be directly connected to the house battery and **NOT** via a master switch to ensure correct shut down cycle of the heater.

Webasto Air Top Installation Guide – AT2000STC

3.1A 620 Ohm Resistor



Connect 620 Ω resistor to wires marked 'Temperature Sensor'

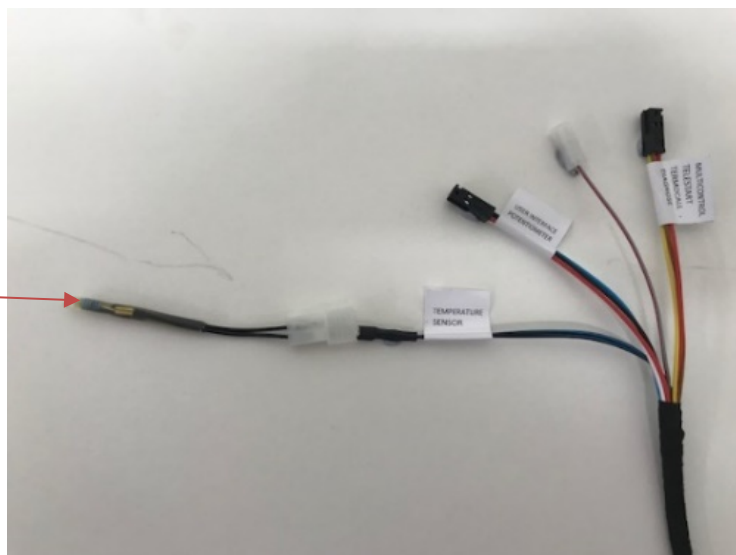

620 Ω resistor supplied loose & in a separate pack within the kit.



Please note – The black wire with blue stripes, with the mini spade terminals - labelled as 'temperature sensor', must be connected to the 620 Ω resistor which is supplied in the kit. Polarity does not matter. If the resistor is not connected when using the multi-controller the error code **F94** will appear. Otherwise, if using the dial controller and the resistor is not connected the error code **F06** will occur.



12V & 24V Heater

F1 = 15A for Heater

F2 = 1A for Multi-Controller



Fig 13 – Fuse holder and fuses supplied in the kit.

The Air Top 2000STC requires 72-85 watts, 6-7 amps during start-up. The main power connection has to be made at a circuit designed to sustain this load without any voltage or current draw. Cigar lighter sockets or auxiliary outputs for any other electronic accessories are not considered adequate for the power supply for the heater.

If any battery management system is used, please contact a Webasto authorised dealer to ensure correct shutdown cycle is maintained and prevent carbon build up.

Webasto Air Top Installation Guide – AT2000STC

3.1 Fuel pump Wiring

A 7m fuel pump harness (Fig 14) is supplied in the kit to connect to the fuel pump. Blue and brown, twin core harness connects to the two black wires out of the combustion air inlet (Fig 3) (3). Polarity does **NOT** matter. Plug kits are supplied; spade terminals or standard automotive electrical connections can be used.

Note: Never run the wires through the combustion air inlet tube, as it will create air restrictions. *Ref: Section 2 – (2.4 & 2.5)*



Fig 14 – Fuel pump wiring harness

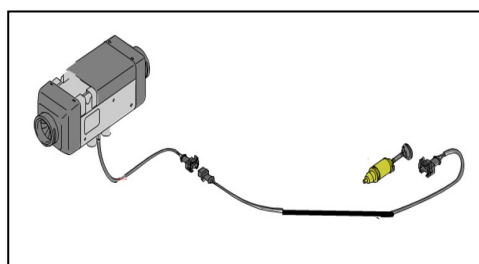

Fig 15 – Wiring to the fuel pump

3.2 Installation of Control Element



Fig 16 – Multi Controller – complete with mounting kit



Fig 17 – Rotary Controller - connects to plug (Fig 10) (X9)

Install the control element in a convenient location. The control element does not measure temperature. The monitoring of temperature is registered via a return air temperature sensor located inside the heater.

Webasto Air Top Installation Guide – AT2000STC

4 Fuel Systems

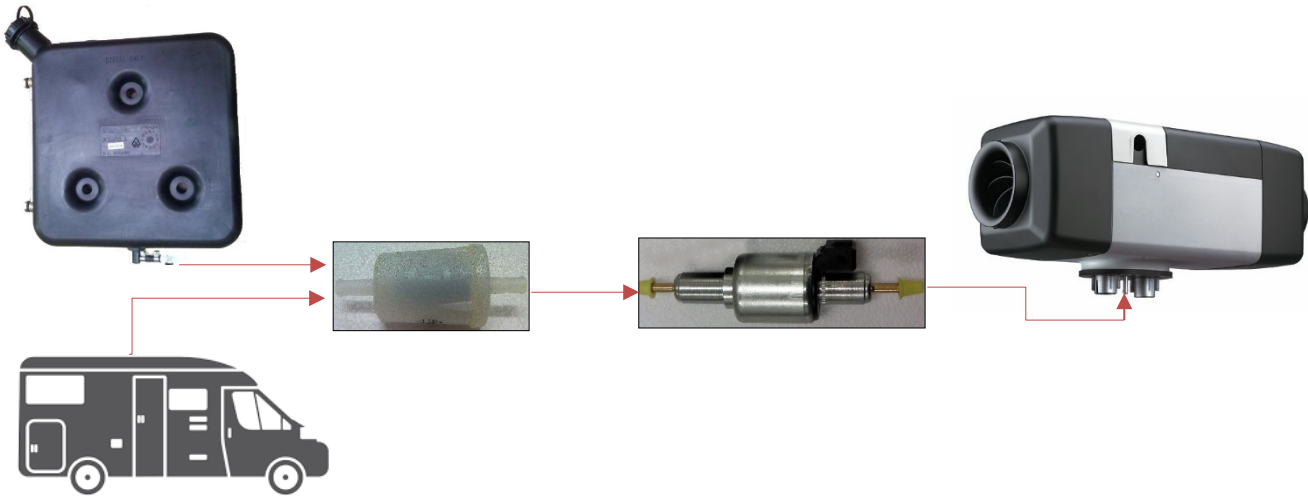

Fig 19 – Sample fuel system layout with Webasto 12Lt plastic fuel and vehicle fuel tank.

For caravans, Webasto can supply a 12L plastic fuel tank with sight level gauge and a quick connect for the fuel line. With Motorhomes, fuel can be sourced out of the vehicle's own fuel tank via a fuel pick up supplied with the kit.

Note: When sourcing fuel from vehicle's fuel tank, do not cut in to the return or supply line for two reasons:

1. Latest model vehicles have highly pressurized fuel systems.
2. If you perform any modifications to the vehicle, you may void the vehicle warranty.

Ensure that the clamps are tight on the fuel filter and the fuel pump and follow the direction of the flow as shown by arrows on the fuel filter and the fuel pump for correct operation. The fuel lines can be protected in conduit and cable ties to secure; these are not supplied in the kit.

4.1 Installation – Fuel Pump

Ensure that the fuel pump is installed with the clamp, 90 degree elbow and the rubber mounting bracket supplied in the kit. This will reduce resonance through the vehicle. (Fig 20)

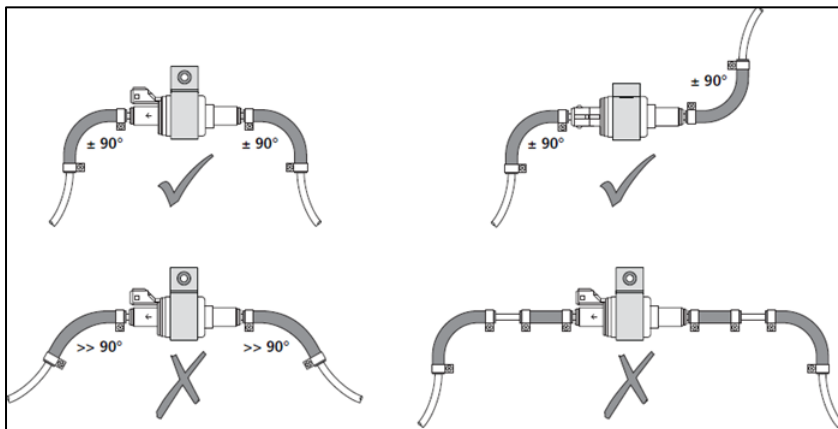

Fig 20 Fuel pump installed with rubber mounting bracket (below)



Webasto Air Top Installation Guide – AT2000STC

4.2 Installation of Fuel Stand Pipe

When fuel is sourced out of the vehicle's fuel tank, ensure that the stand pipe is installed on a flat surface and cut the stand pipe length so that it is 25mm from the bottom of the tank. See Fig 21/22.

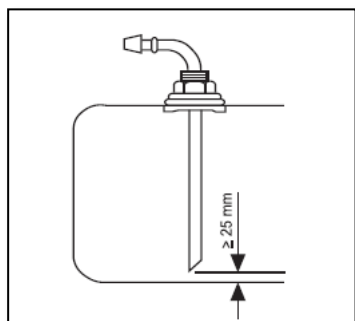

Fig 21 – Installing fuel extracting device – (Top Mount type)

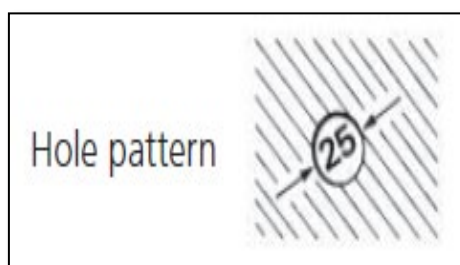

Fig 22 – 25mm - Fuel Extracting Device

Install the tank extracting device as shown Fig 21

Shorten the immersion tube; the end should be approx. 25 mm off the bottom of the tank. Cut the tube diagonally and ensure you deburr the cut edges. (Fig21)

Drill a 25mm hole on the flat surface of the tank (Fig 22). Ensure you grease the drill bit and drilling surface or apply masking tape beforehand (to catch small drilling chips or swarf entering the fuel tank).

Install the fuel pick up and tighten the locking nut (the seal should be slightly compressed; applying any locking glue will be advisable).

4.3 Fuel Filter

To ensure a clean combustion process, a fuel filter is supplied. Always check the direction of flow as marked on the filter (Fig 23). The filter should be installed between the fuel source and the fuel pump.

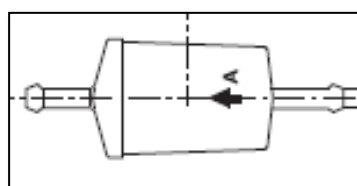

Fig 23 – Webasto Genuine fuel filter



Do not substitute the Webasto supplied fuel filter with non Webasto replacement.

Webasto Air Top Installation Guide – AT2000STC

4.4 Fuel Line

Only Webasto supplied Fuel Line should be used for the fuel delivery to the heater. Use of any other fuel line will result in malfunction of the heater and will void warranty. To ensure correct connections, rubber hose connectors, 10 mm hose clamps and fuel line are supplied in the kit.

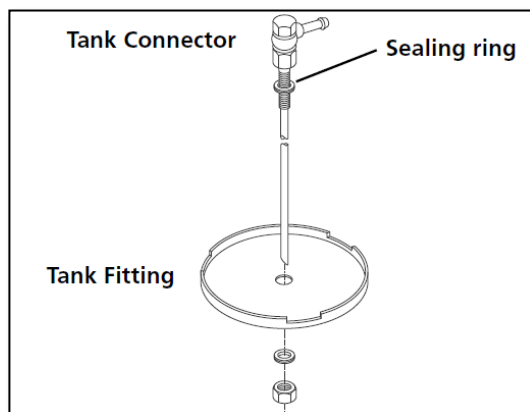

Fig 24 – Installing fuel extracting device - Bottom Mount

In case you are not able to use the stand pipe shown Fig 21 (Top mount type), Webasto can supply another option (Fig 24 bottom mount type).

On some motor-home vehicle chassis' an additional factory fuel spigot may be available at the fuel sender unit, Webasto can supply a connection kit (Fig 25) to suit therefore eliminating the need for a stand-pipe or pick-up.



Fig 25 – Optional SAE Connector for installing on an additional factory fuel spigot

Webasto Air Top Installation Guide – AT2000STC

5 Ducting Layouts

5.1 Sample One Outlet layout

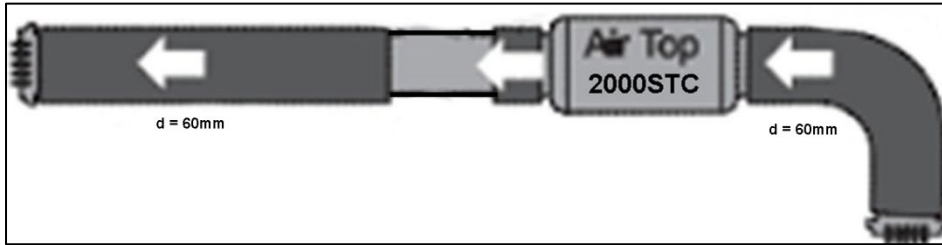

Fig 26

Return Air

5.2 Sample Twin Outlet Layout

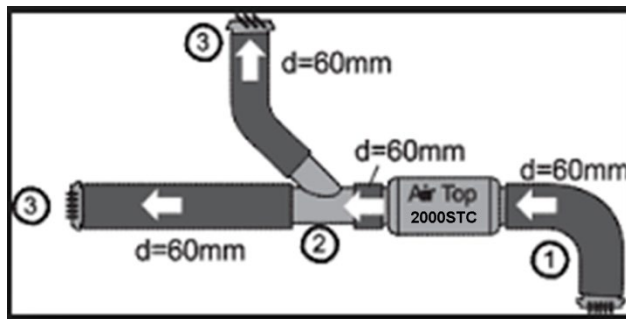
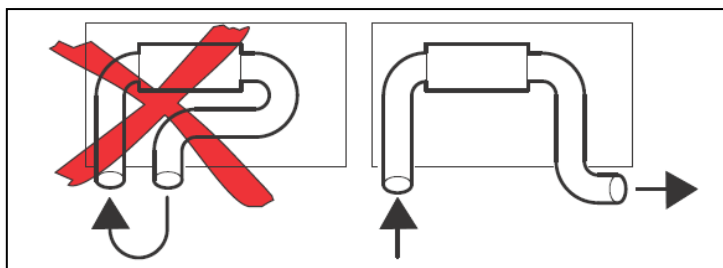

Fig 27

Return Air

COMPONENT	DESCRIPTION
1	RETURN AIR
2	Y-JUNCTION
3	HOT AIR OUTLETS



IMPORTANT!

Fig 28

Ensure that the hot air and return air outlets are at least 1m away from each other or located in different directions to avoid any short cycle. Any short cycle in the system will affect the performance of the heater.

6 Enclosing the heater

- 1) Ensure that the area around the heater is not jam packed while using the compartment as storage as the heater itself and any ducting will get hot (70-80°C).
- 2) Heater can be boxed but it is recommended to have some breathing holes or grills on the enclosure to allow air flow in and around the heater.
- 3) The ducting has to be secured and ensure it cannot be crushed.
- 4) Ensure the ducting connections are properly secured by the clamps supplied in the kit.
- 5) In cases where no return air duct has been applied, ensure you install the 60mm open grill to the return (heating) air side of the heater as supplied in the kit.

DANGER

At no point should a hot vent be located or directed towards a person or areas where people are sitting. Hot air outlet temperature can be between 80°-120°C.

The heat **SHOULD BE** directed away from all body parts.

7 Starting the Heater for the First Time

- 1) Ensure all ducting is connected and secured.
- 2) Ensure all fuel connections and clamps are connected and secured.
- 3) Ensure sufficient fuel is available from your fuel source.
- 4) Ensure that the battery connections are connected and secured.
- 5) Ensure the supplied fuse has been installed. (Check amperage).
- 6) Turn the heater to 100% or MAX.
- 7) Ensure you bleed the fuel system. (See Fuel line bleeding tip).
- 8) It will take at least 5 mins before you will experience hot air out of the hot air vents.
- 9) Leave the heater running for at least an hour.

7.1 Start-up Sequence

The glow plug and the combustion air fan start the operation and combustion process (audible combustion sound of the combustion air fan and the ticking of the fuel pump will be noticeable). The fuel will be delivered and the combustion air fan speed will accelerate and provide hot air.

7.2 Switching Off

When heating is no longer required, switch the heater off by the means of the controller on the heater. Never turn the heater off by the main power supply.

The combustion will be extinguished, followed by a shutdown cooling cycle.

7.3 Fuel Line Bleeding Tip

Turn the heater on with the start-up sequence and the process of the fuel pump will operate. During this operation fuel will be delivered to the heater. Depending on the length of the fuel line this may take a few attempts. During the process the heater will try to start twice and if the fuel has not been delivered, it will show a fault code of F01 - No start (after 2 attempts to start).

You will need to reset the heater by following the reset procedure – see Page 16, Section 9.

Webasto Air Top Installation Guide – AT2000STC

8 Basic Layout of Complete Installation

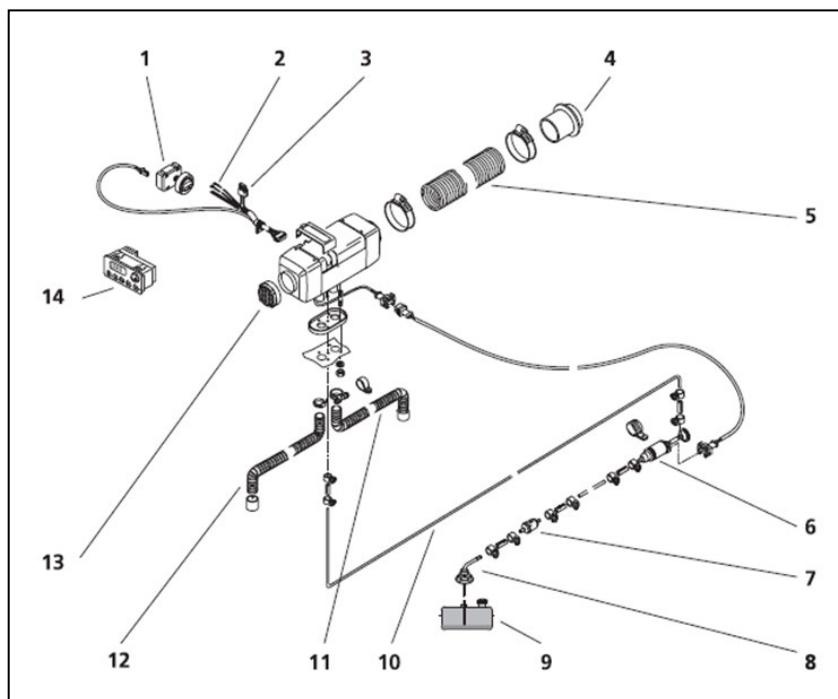

COMPONENT	DESCRIPTION	COMPONENT	DESCRIPTION
1	CONTROLLER	8	FUEL STANDPIPE
2	INTERFACE VEHICLE HARNESS	9	FUEL TANK
3	HEATER FUSES – F1 (15A) & F2 (10A) {Fig. 13 Pg 9}	10	FUEL LINE
4	HOT AIR OUTLET	11	EXHAUST PIPE
5	HOT AIR OUTLET DUCT	12	COMBUSTION AIR INTAKE PIPE
6	FUEL PUMP	13	RETURN (HEATING) AIR INTAKE GRILL
7	FUEL FILTER		

Fig 29 – Basic Complete Installation Layout

9 Reset Procedures

Rotary Control

When the controller starts to flash, disconnect the power supply to the heater by:

- 1) Whilst the controller is in the on position & code flashing, remove the fuse (15A) or disconnect power to the heater
- 2) Turn the dial switch to off
- 3) Wait for a few minutes
- 4) Re-install the fuse
- 5) Restart the heater

Webasto Air Top Installation Guide – AT2000STC

10 Multi-Control Set-Up & Operations Guide

10.1 Set-Up

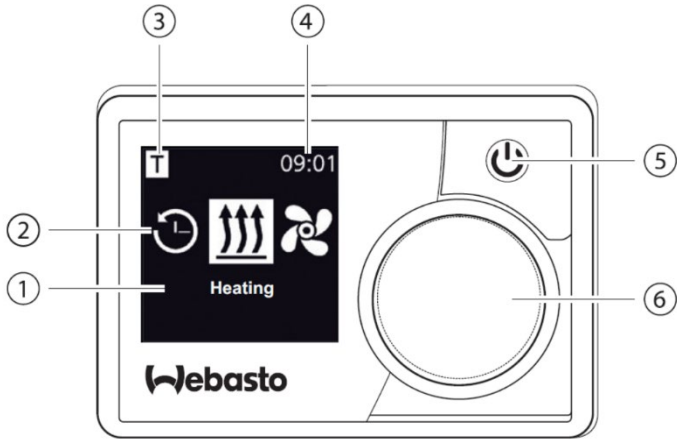

- 1 Menu Name
- 2 Menu Symbols
- 3 Time Setting Activated
- 4 Time
- 5 On / Off Button
- 6 Control Knob



Timer



Heating



Ventilation



Settings

Initial Start-Up

When the Control unit is connected for the first time, a message about the Setting/Configuration of the heater is displayed.



Press the control knob and the On/Off Button simultaneously for 3 seconds

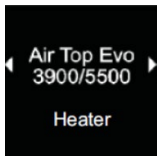

Select your Heater (Note: AirTop Evo 40/55 is displayed as AT 40/55)

Press the Control Knob



Select the current Day

Press the Control Knob

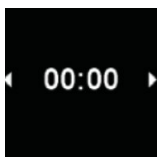

Select the current Time - turn the Control Knob clockwise to select Hour, press the Control Knob to confirm, then turn the Control Knob clockwise again to select the Minutes, press the Control Knob to set.

Press the Control Knob

Webasto Air Top Installation Guide – AT2000STC

If your heater was not selected correctly at Initial Start-Up a Manual Reset is required.

Press the On/Off Button to go to the Main Menu Screen and follow the following steps.

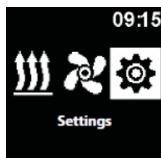

Select the symbol "Settings"

Press the Control Knob

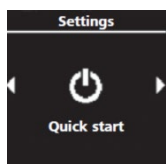

The "Quick Start" menu is displayed

Turn the Control Knob clockwise 10 times until "Reset" is displayed

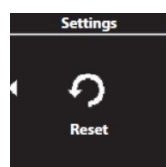

Select "Reset" by pressing the Control Knob

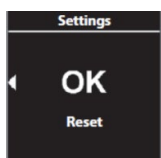

Press the Control Knob to confirm.

The Control Knob is now restarted

During the restart of the Control Knob, an Hourglass will quickly appear

Press the Control Knob and the On/Off Button simultaneously for 3 seconds

The Control is now ready for use.

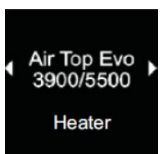

Select your Heater (Note: AirTop Evo 40/55 is displayed as AT 40/55)

Press the Control Knob

Webasto Air Top Installation Guide – AT2000STC

10.2 Timer Set-Up

It is possible to program the Timer Setting 7 days in advance. The heater switches on automatically at the programmed time. Up to 3 time settings per day can be set, with a total of 21 time settings for the week.

Before the timer can be activated, make sure that the:

- Time and current day of the week are set,
- Heater is switched off
- “Timer” symbol has been selected in the main menu

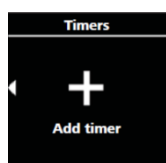
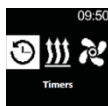

Press the Control Knob

“Add Timer” screen is displayed

Press the Control Knob in order to add a new timer

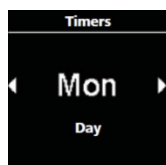

Turn the Control Knob to select chosen “Day”

Press the Control Knob to confirm selection

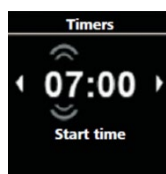

Turn the Control Knob to choose the desired Switch On time (Hour)

Press the Control Knob to confirm

Turn the Control Knob again to choose the Minutes

Press the Control Knob to confirm

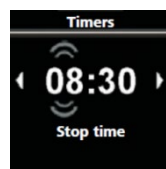

Turn the Control Knob to choose the desired Switch OFF time (Hour)

Press the Control Knob to confirm

Turn the Control Knob again to choose the Minutes

Press the Control Knob to confirm

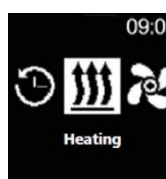

Select the “Heating” operation mode from the Main Menu screen

Webasto Air Top Installation Guide – AT2000STC

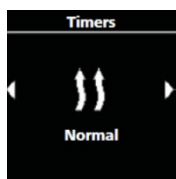

Turn the Control Knob to choose the desired heating mode

Options available: Eco (Power Saving Mode); Normal (Comfort Heating); Boost (Rapid Heat)

Press the Control Knob to confirm selection

NOTE: Eco and Boost modes are not available for the AT2000STC

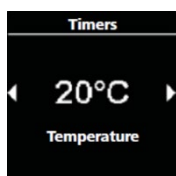

Turn the Control Knob in order to choose the desired temperature

(Temperature range: 5 - 35°C)

Press the Control Knob to confirm selection

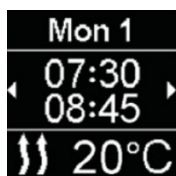

The programmed timer is saved and shown on the display



Press the Control Knob to activate the programmed time

“Activate” message will appear on the display

Repeat the process to add timers (3 timer settings per day, 21 per week)

Webasto Air Top Installation Guide – AT2000STC

11 Preventive Maintenance

To ensure trouble-free operation of your Webasto heater, please observe the following:

- 1) Operate heater for at least an hour once a month, regardless of the season
- 2) Keep return air inlet and hot air outlet free of obstructions to prevent overheating
- 3) Keep combustion air inlet and exhaust outlet tube free of dirt and obstructions
- 4) Change fuel filter annually (depending on the usage)
- 5) Bio Diesel or any fuel additive is not permitted
- 6) 15A fuse for both 12V and 24V heaters



Note: The build-up of Carbon is not a warrantable condition.

Situations that may cause Carbon build-up in the heater are:

- Under Voltage: the system should have at least 12.5-13V;
- Low current: the system requires 7-8A for the initial start-up phase for 120 seconds and once the flame is established the glow plug goes out and heater continues running at 2-3A;
- Under size wire: where extensions are made to the battery positive & negative cables only, ensure that correct wire size is used;
- Fuel system: poor fuel quality, air pockets in the fuel line or running out of fuel;
- Combustion system: any blockage or restriction in the combustion air tube or at the silencer;
- Exhaust system: any blockage or restriction in the exhaust muffler or pipe;
- Isolation switch or circuit breaker: can prevent the heater from performing a correct shut down cycle. The battery positive & negative wire should be connected directly to the battery;
- Electrical connections: poor battery connections, poor Earth, loose fuses and improper crimping of terminals or plugs.

The build-up of Carbon is not a product malfunction however; the above listed are external factors that could affect the performance of the heater.

12 Fault Code

In the event of a failure a flash code will be generated on the indicator light of the Rotary Control (On/Off) switch. In order to make a correct analysis, it is necessary to understand the fault code. The flashing code will be visible during the cool down period of the operation.

During the flash code event you will see five quick flashes followed by a sequence of slow flashes, the sequence of slow flashes is the actual fault code. The five quick flashes are only an indication that a fault has occurred.

Count only the slow sequence of the flashes to obtain the current fault code.

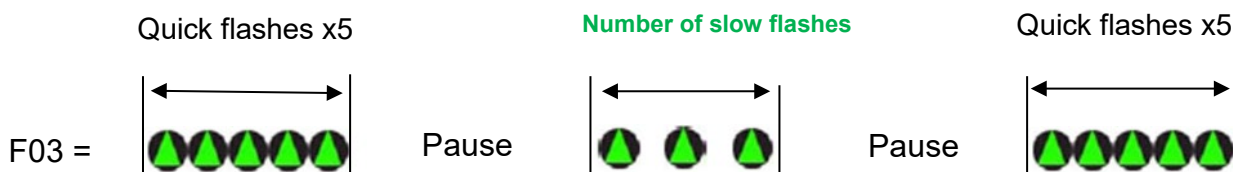

E.g. Code F03 = low or high battery voltage

Webasto Air Top Installation Guide – AT2000STC

12.1 Heater Flashing Fault Code Description

Fault code output: Flashing / FXX	Fault message	Fault details	Recommended measures
F00	Defective control unit	Control unit defective EOL programming error	1) Check for fault in area of W-bus communication/W-bus control element/W-bus Telestart 2) Replace control unit
F01	No start	No flame formed even after repeated start attempt	1) Check for fault in air intake and exhaust systems 2) Check for fault in fuel system 3) Check fuel pump 4) Electrical check of glow plug
F02	Flame failure	The flame goes out during operation and no longer reformed after a restart attempt.	See error 01
F03	Supply Voltage too high	The operating voltage was higher than the maximum permissible value for too long	Check system voltage
F04	Flame was detected prior to combustion	The flame monitor detected a flame before combustion started	1) Check for fault in air intake, exhaust systems 2) Check for fault in fuel system 3) Check fuel pump 4) Electrical check of glow plug
F05	Flame sensor interruption	There is a break or short to UB in the electrical circuit of the flame detector	Electrical check of flame monitor
F06	Temperature sensor interruption (internal, external)	There is a break or short to UB in the temperature sensor	Electrical check of external/internal temperature sensor
F07	Fuel pump interruption	There is a break or short to UB in the electrical circuit of the fuel pump	Electrical check of fuel system
F08	Combustion air fan short circuit	The combustion air fan has a short to ground or the fan motor is overloaded	Electrical check of combustion air fan motor
	Combustion air fan blocked	Combustion air fan blocking guard has tripped	1) Check for fault in fan motor 2) Heating air intake fan wheel snagging or jammed 3) Combustion air intake fan wheel snagging or jammed
F09	Glow plug / electronic ignition unit interruption	There is a break or short to UB in the glow plug/ignition spark generator	Electrical check of glow plug
F10	Heating unit overheated	Overheating lock-out has tripped (heater overheated)	1) Check for fault in air intake/blow-out side, exhaust systems 2) Check for fault in fuel system
F11	Overheat sensor interruption	There is a break or short to UB in the electrical circuit of the overheating sensor	Electrical check of overheating sensor

Webasto Air Top Installation Guide – AT2000STC

Fault code output: Flashing / FXX	Fault message	Fault details	Recommended measures
F12	Heater lock-out	Heater lock-out was activated	<p>1) Reset heater lock-out and attempt restart</p> <p>2) Read out further fault messages and work through instructions</p> <p>Reset heater lock-out: switch on heater. Pull fuse F1 for at least 10 s. Switch off heater. Reinsert fuse F1. Switch on the heater.</p> <p>NOTE</p> <p>Following fault occurred several times:</p> <p>Fault counter: > 10x</p> <p>False start counter: > 7x</p> <p>Overheating counter: > 20x</p>
F14	Gradient undershooting during start	Wrong position of overheating sensor (overheating sensor gradient too small)	<p>1) Check position of overheating sensor</p> <p>2) Check fuel supply system</p>
F15	Setpoint potentiometer interruption	There is a break or short to UB in the electrical circuit of the setpoint potentiometer	Electrical check of setpoint sensor

Webasto Air Top Installation Guide – AT2000STC

12.2 Heater Digital Multi Control display Fault Code Description

Fault code output: HEX	Fault message	Fault details	Recommended measures
00	No error	No error	No action necessary
01	Defective control unit	Defective control unit, wrong end-of-line programming or coolant temperatur sensor (at water heaters) failure	Replace control unit
02	No start	After start-up has been repeated, combustion still fails to occur	1) Check for fault in air intake and exhaust systems 2) Check for fault in fuel system 3) Check fuel pump 4) Electrical check of glow plug
03	Flame failure	The flame went out during operation and combustion.	See error 02
04	Supply Voltage too high	Supply voltage was too long above maximum threshold value	Check system voltage
05	Flame was detected prior to combustion	Flame detector signals flame before combustion operation	1) Check for fault in air intake, exhaust systems 2) Check for fault in fuel system 3) Check fuel pump 4) Electrical check of glow plug
06	Heating unit overheated	Overheat protection has been activated or the temperature at the heat exchanger has exceeded the upper limit	1) Check for fault in air intake/blow-out side, exhaust systems 2) Check for fault in fuel system
07	Heater lock-out	Heater interlocked	1) Reset heater lock-out and attempt restart 2) Read out further fault messages and work through instructions Reset heater lock-out: switch on heater. Pull fuse F1 for at least 10 s. Switch off heater. Reinsert fuse F1. Switch on the heater. NOTE Following fault occurred several times: Fault counter: > 10x False start counter: > 7x Overheating counter: > 20x
08	Fuel pump short circuit	Fuel pump has short circuit to ground	Electrical check of fuel system
09	Combustion air fan short circuit	Combustion air fan has short circuit to ground	Electrical check of combustion air fan motor
11	Wrong fuel coding	Incorrect parameter block or wrong heater (diesel/gasoline) used	Replace control unit

Webasto Air Top Installation Guide – AT2000STC

Fault code output: HEX	Fault message	Fault details	Recommended measures
12	W-bus communication failure	W-Bus communication failure	1) Check for fault in area of W-bus communication/W-bus control element/W-bus Telearstart 2) Replace control unit
14	Temperature sensor short circuit (internal, external)	Temperature sensor has short circuit to ground	Electrical check of external/internal temperature sensor
15	Combustion air fan blocked	Combustion air fan is blocked	1) Check for fault in fan motor 2) Heating air intake fan wheel snagging or jammed 3) Combustion air intake fan wheel snagging or jammed
17	Gradient exceedance overheat protection	The temperature rise at the heat exchanger has exceeded the upper limit.	Check for fault in air intake/blow-out side, exhaust systems
18	Communication failure on customer specific bus	Communication failure on customer specific bus	-
19	Glow plug / flame monitor short circuit	Glow plug / electronic ignition unit has short circuit to ground	Electrical check of glow plug
81	EOL checksum error	Checksum of EOL dataset is wrong	Replace control unit
82	No start during test-run	No start during test-run	See error 02
83	Flame failure	Flame interruption during combustion operation, more than FAZ (EEPROM) times.	See error 02
84	Operating voltage too low	Supply voltage was too long below maximum threshold value	Check system voltage
88	Fuel pump interruption	Fuel pump interrupted or short circuit to supply voltage UB	Electrical check of fuel system
89	Combustion air fan interruption	Combustion air fan interrupted or short circuit to supply voltage UB	Electrical check of fan motor
91	Wrong control unit coding	Control unit locked or coded as neutral	Replace control unit
92	Command refresh failure	Command refresh failure	Check for fault in area of W-bus communication/W-bus control element/W-bus Telearstart
94	Temperature sensor interruption (internal, external)	Temperature sensor interrupted or short circuit to supply voltage UB	Electrical check of external/internal temperature sensor
97	Gradient undershooting during start	Overheat sensor position wrong (temperatur gradient too low)	1) Check position of overheating sensor 2) Check fuel supply system
99	Glow plug / electronic ignition unit interruption	Glow plug / electronic ignition unit interrupted or short circuit to supply voltage UB	Electrical check of glow plug
0 A	Glow plug / flame monitor short circuit	Glow plug/Flame monitor circuit has short circuit to ground	Electrical check of glow plug
1 A	Flame sensor short circuit	Flame sensor has short circuit to ground	Electrical check of flame monitor

Webasto Air Top Installation Guide – AT2000STC

Fault code output: HEX	Fault message	Fault details	Recommended measures
1B	Overheat sensor short circuit	The overheat sensor has a short circuit to ground	Electrical check of overheating sensor
8 A	Glow plug / electronic ignition unit interruption	Glow plug/Flame monitor interrupted or short circuit to supply voltage UB	Electrical check of glow plug
9 A	Flame sensor interruption	Flame sensor interrupted or short circuit to supply voltage UB	Electrical check of flame monitor
9B	Setpoint potentiometer interruption	Setpoint potentiometer interrupted or short circuit to supply voltage UB	Electrical check of setpoint sensor
AB	Overheat sensor interruption	Overheat sensor interrupted or short circuit to supply voltage UB	Electrical check of overheating sensor

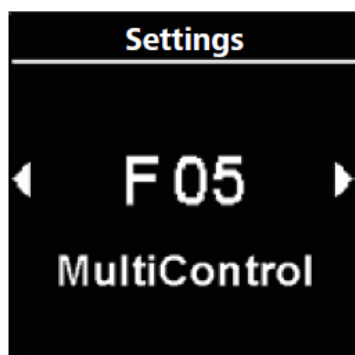

12.3 YouTube Tutorial Links

YouTube tutorial on how to configure the multi controller to the correct model of heater, when there is **T12 error**.
<https://www.youtube.com/watch?v=qhXJOSPkqIM>

YouTube tutorial on the operation of the multi controller.
<https://www.youtube.com/watch?v=vvXBKKA8n6U>

YouTube tutorial to learn more about general troubleshooting AT2000STC
<https://www.youtube.com/watch?v=WfA-xpvCWHg>

YouTube tutorial when 'No Power'
<https://www.youtube.com/watch?v=VfteUuccgwQ>

YouTube tutorial on the exhaust & air intake system
<https://www.youtube.com/watch?v=WfA-xpvCWHg>

Webasto Air Top Installation Guide – AT2000STC

12.4 Digital Multi Controller error table

Error code	Fault	Fault description	Fault remedy
Te _d	Overvoltage	Supply voltage is above 36 V.	Check vehicle electrical installation.
Te ₃	Display background lighting defective		Contact Technical Support/Customer Service.
Te ₄	Status LED defective		Contact Technical Support/Customer Service.
Te ₅	Temperature sensor fault	Temperature sensor of the MultiControl/SmartControl defective.	Contact Technical Support/Customer Service.
Te ₆	W bus temperature sensor fault	Temperature from the external sensor (W bus) cannot be read correctly.	Check installation. Replace the sensor, if necessary.
T _{5d}	UniBox temperature sensor fault	Temperature from the external sensor connected to the UniBox cannot be read correctly.	Check installation. Replace the sensor, if necessary.
T ₁₂	Communication fault on the W bus		Check installation.
Te _{7/Te8}	Flash	Reading/writing from/to the internal memory has failed.	Contact Technical Support/Customer Service.
Te _a	Faulty feedback signal from the heater (ST)		Check installation.
Te _c	Jamming control knob	A control knob is pressed for longer than 10 seconds.	Contact Technical Support/Customer Service.
T ₄₆	Overcurrent/short-circuit at switching output SAU1	Current is higher than 500 mA.	Check installation. Ensure that the consumer at switching output SAU1 does not draw a higher current than 500 mA.
T ₄₉	Overcurrent/short-circuit at switching output SAU2	Current is higher than 20mA.	Check installation. Ensure that this switching output is only connected to the corresponding heater.
Te ₀	Reduced voltage	Supply voltage is below the value set by the technician.	Recharge the battery and check the vehicle's electrical installation
T ₈₄	Low voltage	Supply voltage is below 8V.	Recharge the battery and check the vehicle's electrical installation
Te ₁	Ambient temperature too low/high	Ambient temperature is outside the working range of -20°C to +70°C.	The fault disappears automatically when the ambient temperature returns to the working range of -20°C to +70°C.
Te _b	RTC error	The internal clock chip of the MultiControl/SmartControl has lost its setting.	In the event of interruptions in the power supply of more than 8 minutes: Enter the date and time again. If the error occurs without an interruption in the power supply: Contact Technical Support/Customer Service.
Te _e	Defective switching transistor in the MultiControl/SmartControl		Contact Technical Support/Customer Service.
Attention: If this fault occurs, the heater can no longer be switched off. Please remove the fuse immediately and drive to a workshop.			

13 Optional Parts

PART NUMBER	DESCRIPTION
1322632A	FUEL STAND PIPE (BOTTOM MOUNT TYPE – FIG 24)
1321156A	SAE CONNECTOR FUEL – FIG 25
4152601	EXHAUST LAGGING
92223B	'L' BRACKET (WALL MOUNT)
1319724A	CONTROLLER EXTENSION HARNESS, 1800mm Long
1319724L	CONTROLLER EXTENSION HARNESS, 6000mm Long
KTH9012294A	60mm 45° VENT
1320474A	60x60x60mm 'Y' JUNCTION
1311898C	60mm DUCTING

Note: The comprehensive one and two outlet kits are supplied with all necessary components required for installation, however should additional items be required for more complex installations please use the above list or contact your nearest Webasto Authorised dealer.

Webasto Air Top Installation Guide – AT2000STC



Webasto Thermo & Comfort Australia Pty Ltd
423-427 The Boulevard, Kirrawee NSW 2232 Australia

Ph: +61 (0)2 8536 4800

svc-info@webasto.com
www.webasto.com

